

Sr. No.	Company Name	Location
1	SOPHOS	Inside Main Office (X-016)
2	SOPHOS	Above V-Print (X-015)
3	SOPHOS	Inside Staff Room (X-011)
4	SOPHOS	Tree Area (X-002)
5	SOPHOS	Tree Area (X-007)
6	SOPHOS	Outside Exam cell (X-109)
7	SOPHOS	Outside X-114
8	SOPHOS	Y Block
9	SOPHOS	Y – Reading Room



Darell
Principal
Vidyalankar School of
Information Technology
Antop Hill, Wadala (E),
Mumbai-400 037.

Sr. No.	Make	Model	Configuration	System Memory	Storage	OS	Purpose
1	IBM	IBM System X3650M4	Xeon 16 core Processor 2.6 GHz / 1866 MHz	32 GB RAM – 1600 MHz	300x2 GB HDD – 10K	Windows Server 2012 R2 Data Centre	Cluster
2	IBM	IBM System X3650M4	Xeon 16 core Processor 2.6 GHz / 1866 MHz	32 GB RAM – 1600 MHz	300x2 GB HDD – 10K	Windows Server 2012 R2 Data Centre	Cluster
3	IBM	IBM System X3650M4	Xeon 16 core Processor 2.6 GHz / 1866 MHz	32 GB RAM – 1600 MHz	300x2 GB HDD – 10K	Windows Server 2012 R2 Data Centre	Cluster
4	IBM	IBM System X3650M4	Xeon 16 core Processor 2.6 GHz / 1866 MHz	24 GB RAM – 1600 MHz	300x2 GB HDD – 10K Storage 4 TB	Windows Server 2008 R2 Professional	Backup
5	IBM	IBM System X3650M4	Xeon 16 core Processor 2.6 GHz / 1866 MHz	24 GB RAM – 1600 MHz	300x2 GB HDD – 10K	Windows Server 2008 R2 Professional	N Computing
6	Gigabyte	B85M-DS3H-A Gigabyte Technology	Intel(R) core™ i5-4440 CPU@3.10GHz	8 GB DDR 3	6 TB	UBUNTU 16.04	LMS
7	Gigabyte	H97M-D3H Gigabyte Technology	Intel(R) core™ i5-4590S CPU@3 GHz 2 Socket	16 GB DDR3	16 TB	UBUNTU 16.04	LMS
8	Gigabyte	H97M-D3H Gigabyte Technology	Intel(R) core™ i5-4590S CPU@3 GHz 2 Socket	16 GB DDR3	16 TB	UBUNTU 16.04	LMS
9	HP	HP ProLiant DL 120	Xeon	4 GB	1 TB	Linux	V-refer
10	HP	HP ProLiant DL 120	Xeon	4GB	1 TB	Linux	V-repo



Rakela

Principal
Vidyalankar School of
Information Technology
Antop Hill, Wadala (E),
Mumbai-400 037.

Storage Details	
Model Name	Storage
IBM DS4200	12 TB
Fujitsu ET06L12AG	3 TB
Imega NAS	1TB

IBM Server Details:

Name	Computer system	CPU	Motherboard	System memory	Hard disk drive	OS information	Core
wdc-srv-vm2	IBM System X3650M4	Xeon 16 core Processor 2.6 GHz / 1866 MHz	IBM System X3650 M4	32 GB RAM – 1600 MHz	300x2 GB HDD – 10K	Windows Server 2012 R2 Data Centre	16
wdc-srv-vm3	IBM System X3650M4	Xeon 16 core Processor 2.6 GHz / 1866 MHz	IBM System X3650 M4	32 GB RAM – 1600 MHz	300x2 GB HDD – 10K	Windows Server 2012 R2 Data Centre	16
wdc-srv-vm4	IBM System X3650M4	Xeon 16 core Processor 2.6 GHz / 1866 MHz	IBM System X3650 M4	32 GB RAM – 1600 MHz	300x2 GB HDD – 10K	Windows Server 2012 R2 Data Centre	16
Backup server	IBM System X3650 M4	Xeon 16 core Processor 2.6 GHz / 1866 MHz	IBM	24 GB RAM – 1600 MHz	300x2 GB HDD – 10K Storage 4 TB	Windows Server 2008 R2 Professional	8
Ncomputing	IBM System X3650 M4	Xeon 16 core Processor 2.6 GHz / 1866 MHz	IBM	24 GB RAM – 1600 MHz	300x2 GB HDD – 10K Storage	Windows Server 2008 R2 Professional	8



Lecture Capture Management Server

Name	Computer system	CPU	Motherboard	System memory	Hard disk drive	OS
LMS Server 1	B85M-DS3H-A Gigabyte Technology	Intel(R) core™ i5-4440 CPU@3.10GHz	B85M-DS3H-A	DDR 3-8GB	6 TB	UBUNTU 16.04
LMS Server 2	H97M-D3H Gigabyte Technology	Intel(R) core™ i5-4590S CPU@3 GHz 2 Socket	H97M-D3H	DDR 3-16GB	16 TB	UBUNTU 16.04

HP Server Details:

Name	Computer system	CPU	Motherboard	System memory	Hard disk drive	OS
ERP.WDC.VIDYALANKARLIVE.COM	HP ProLiant DL 120	Xeon	HP	4GB	1TB	Linux
ERP Back Up Server	HP ProLiant DL 120	Xeon	HP	4GB	1TB	Linux

Storage Details:

Name	WDC-SAN
Model Name	Fujitsu ET06L12AG
Serial Number	YL2C001364
Hard disk drive	SEAGATE HDD (300 GB * 10)

Name	WDC-SAN
Model Name	IBM DS4200
Hard disk drive	12 TB



ISP Details:

Name	Description
Vodafone	500 Mbps
Hathway	300 Mbps

Switch

Name	Location
Switch-2 (Core Switch)	VIT Server Room Core Switch
Switch-1 (Core Switch)	VIT Server Room Core Switch
D link	VSIT MAIN SWITCH
Cisco L2	VSIT Office
D link	Lab X103
D link	
D link	
D link	
Cisco L2	
Cisco L2	
D link	Lab X114
D link	Lab X119
D link	
Cisco L2	Lab X120
D link	Lab X121
Cisco L2	Lab X122
Cisco L2	Lab X123
Cisco L2	Lab X019
D link	Lab Y101
D link	
D link	Library
D link	Reading room
D link	Exam Cell
D link	DEPDS

Firewall

Name	CPU	Memory	Serial No.
NSA 3500	4x550MHz Mips64 Octeon Processor	512 MB RAM, 512 MB Flash	0017C514558C
Sophos 430	Intel Xeon Quad Core E3- 1225v5 @3.3 GHz	16 GB DDR4,240 SSD	S40008215AF802C



WIFI Access Point

Name	Count
SOPHOS A55	9



Servers							
Year	Description	Date Of Purchase	QTY	Vendor	Po. No.	Price	Status
2012-2013	IBM X 3650 M4 2U Rack Server	23/07/2012		2 Veltech	1901	321100	Expired
2014-2015	IBM X3650 M4 Xeon2U Rack Server	30/06/2014		3 Techflex		1260000	Active
2017-2018	SAN IBM DS4200 12 TB	2018-10-04 (3Years)		1 Techflex	3311	656189	Active

Renewal							
2019-2020	IBM X3650 M4 Xeon2U Rack Server	27/11/2019		3 Techflex		1,09,032	
2020-2021	IBM X3650 M4 Xeon2U Rack Server	08-12-2020		3 Techflex		86000	
2021-2022	IBM X3650 M4 Xeon2U Rack Server	08-12-2021		3 Techflex		86000	Active
2021-2022	SAN IBM DS4200 12 TB	06-11-2021		1 Techflex		1,65,274	Active





TechFlex Solutions Pvt Ltd
 F-412, Kailas Industrial Complex, Veer
 Sawarkar Marg, Near Hiranandani, Vikhroli
 W - 400079
 ContactNo:-022-41207788
 Email ID:-sheetalj@techflex.co.in
 State Code:-27

Tax Invoice

Bill To M/s. VIDYALANKAR DNYANAPEETH TRUST S VIDYALANKAR SCHOOL OF INFORMATION TECHNOLOGY Vidyalankar College Marg, Wadala (E), Mumbai-400037 Contact No.4129936 GST No. State Code:27 Contact Person:Mr. Sunil Tubhe	Ship To M/s. VIDYALANKAR DNYANAPEETH TRUST S VIDYALANKAR SCHOOL OF INFORMATION TECHNOLOGY Vidyalankar College Marg, Wadala (E), Mumbai-400037	Invoice No. TF-0477/Mar-2021 Invoice Date : 16/03/2021 Customer PO No.04444 PO Date :24/02/2021
---	--	--

Sr. No.	Part No	Product Description	HSN	Unit Price	Qty	Tax(%)		Amount
						cgst	sgst	
1	IBM - HW MA-SWMA	IBM AMC SERVICES, AMC for IBM MX3650 Server 1Year,Parts, Labour, On Site, 24x7 4Hr response Serial No: 06BYNGK/06BYNGH/06BYNGG Support: 09/12/2020 To 08/12/2021	998713	28666.67	3	9.00	9.00	86000.01

Bank Details : State Bank of India, Vikroli West Branch - Branch no - 01406 , Account No - 33177702210, IFS Code - SBIN0001406	Subtotal :	86000.01
Amount in words : Rupees One Lakh One Thousand Four Hundred Eighty Only	CGST 9% :	7740.00
	SGST 9% :	7740.00
	Grand Total	101480.00

- Terms & conditions :**
- 1) Payment term : Against Invoice
 - 2) Warranty voids if payment commitment failed.
(Bounced cheque will also considered as failed commitment)
 - 3) Interest @ 24% will be charged on overdue payment.
 - 4) Goods once sold will not be taken back.
 - 5) No TDS on Software Sales



Company's GST No : 27AAECT6857HIZW
 Company's PAN No : AAECT6857H

Note:

Declaration : I/We hereby certify that my/our registration certificate under the Maharashtra Value Added Tax Act 2002 is in force on the date on which the sale of goods specified in this tax invoice is made by me/us and the transaction of sale covered by this tax invoice has been effected by me/us and it shall be accounted for in the turnover of sales while filling of return and the due to tax, if any payable on the sale has been paid or shall be paid.

for TechFlex Solutions Pvt Ltd



Authorised Sign

DesignTech Systems Pvt. Ltd.
(Formerly known as DesignTech Systems Limited)

Billing Address -

Shop No.2, "Dyananda",
Post Bhugaon, Tal. Mulshi,
Dist. Pune - 412 115 (Maharashtra),
India.

☎ Pune : +91 - 20 - 4131 1200 / 1201
✉ info@designtechsys.com
🌐 www.designtechsys.com
CIN-U72200MH1998PTC113636

DesignTech
Technology for designing the future

Tax Invoice

Consigner Details GSTIN : 27AA8CD2335F1Z2 PAN : AABCD2335F		Date of Supply : 09/12/2021 Time of Supply : 14:45 Place of Supply/ Delivery : Maharashtra		Invoice No. : MH/2122/40347 Invoice Date : 09/12/2021 Customer Order No. : 04649 Dated: 29-11-2021 E-Way Bill No. : E-Way Bill Date : IRN No. :	
Details of Receiver (Billed To) Customer Code : C04645 Name : Vidyalankar Institute Of Technology Vidyalankar Institute Of Technology, Vidyalankar College Marg, Wadala (E), Vidyalankar Dnyanapeeth Trust's Mumbai - 400037 INDIA State : Maharashtra State Code : 27 GSTIN No. : Pan No. : AAATV2195F		Details of Consignee (Shipped To) Name : Vidyalankar Institute Of Technology Vidyalankar Institute Of Technology, Vidyalankar College Marg, Wadala (E), Vidyalankar Dnyanapeeth Trust's Mumbai - 400037 INDIA State : Maharashtra State Code: 27 GSTIN No. : Pan No. : AAATV2195F		Contact Person : Dr. Milind Tadvalkar Contact No. : 022-24161126 End Cust - Name : Vidyalankar institute Of Technology Pan No. : AAATV2195F	

Our Bankers :

Bank Name : State Bank of India
Branch Address : Senapati Bapat Road, Pune 411 016

A/c No. : 38036630496
IFSC Code : SBIND004108
MICR Code : 411002050

S.No.	Part Code	Description of Goods	HSN/SA C Code	Qty	Rate	Amount	Disc.	Taxable Value	CGST		SGST		Total (INR)
									Rate %	Amount	Rate %	Amount	
1	MW-Campus Wide Suite (CWS)-R	MW-Campus Wide Suite (CWS) Renewal	998319	1.00	822824.00	822,824.00		822,824.00	9.0	74054.16	9.0	74054.16	970,932.32
Total						822,824.00		822,824.00		74,054.16		74,054.16	
Total Amount Before Tax												822824.00	
CGST @ 9.000%												74,054.16	
SGST @ 9.000%												74,054.16	
Total Invoice Value (In Words) :Rupees Nine Lakhs Seventy Thousand Nine Hundred Thirty-Two Only												Total Amount After Tax : 970932.00	

Remarks : License No.: 40874701
SMS Period: 01.01.2022 to 31.12.2022



Overdue interest @ 18% will be charged if payment is not received before due date
Certified that the Particulars given above are true and correct and the amount indicated

For DesignTech Systems Private Limited

Authorized Signatory

Electronic Reference Number

Invoice Generated By : Shyam

Page 1 of 1

DesignTech Systems Pvt. Ltd.
(Formerly known as DesignTech Systems Limited)

Head Office -

6, Commerce Centre, Rambaug Colony, Paud Road, Pune - 411 038 (Maharashtra), India. Tel.: +91 - 20 - 4131 1200 / 1201



Purchase Order

To,

TECHFLEX SOLUTIONS PVT LTD

F406, KAILAS IND COMPLEX VEER SAWARKAR MARG, VIKHROLI(W), MUMBAI 79 - 400079

PO Number : 04640

PO Date : 24-11-2021

-/

Contact Person :---

Please arrange to supply following to Vidyalankar Institute of Technology.

Furnish Delivery Challan and Cash Memo / Invoice along with delivered goods.

Sr. No.	Item Name	Item Remarks	Quantity	Unit Rate (₹)	Total Amount (₹)	Add Taxes (GST)
1	SERVICE CONTRACT	AMC - LENOVO THINKSYSTEM SFF STORAGE (QTY 1 } -MODEL: DS4200 MT-M:4617 HC2 SN: J34B2P5	1(Number)	165274.00	165274.00	18.00
Total Amount :					165274.00#	# + Taxes as Above
Round Off Amount :					₹ 165274.00	
Amount in Words :One Lakh Sixty Five Thousand Two Hundred and Seventy Four rupees only						

PO Remarks :PERIOD : 06.11.21 TO 05.11.22 (1 YEAR / 24X7 SUPPORT)

*AMOUNT WILL BE PAID AS PER PURCHASE ORDER OR AT ACTUALS, WHICHEVER IS LESS.

Principal

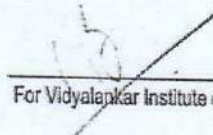
For Vidyalankar Institute of Technology (VIT)





TechFlex Solutions Pvt Ltd
 F-412, Kailas Industrial Complex, Veer
 Sawarkar Marg, Near Hiranandani,
 Vikhroli W - 400079
 ContactNo:-022-41207788
 Email ID:-sheetalj@techflex.co.in
 State Code:-27

Tax Invoice

Bill To M/s. VIDYALANKAR DNYANAPEETH TRUST'S Vidyalankar Institute of Technology (VIT) Vidyalankar College Marg, Wadala (E), Mumbai-400037 Contact No.24161126 GST No. State Code:27 Contact Person:Mr. Sunil Tubhe	Ship To M/s. VIDYALANKAR DNYANAPEETH TRUST'S Vidyalankar Institute of Technology (VIT) Vidyalankar College Marg, Wadala (E), Mumbai-400037	Invoice No. TF-0420/Dec-2021 Invoice Date : 07/12/2021 Customer PO No. 04640 PO Date : 24/11/2021
--	---	---

Sr. No.	Part No	Product Description	HSN	Unit Price	Qty	Tax(%)		Amount
						cgst	sgst	
1	AMC	ANNUAL MAINTENANCE CONTRACT, Lenovo Thinksystem DS4200 SFF Storage AMC Machine type MODEL 4617 hc2 SLA - Premier Essential-1Yr Post Wty 24x7 4Hr Resp+YDYD DS4200 Serial No: J34B2P5 Support: 06/11/2021 To 05/11/2022	9983	165274.00	1	9.00	9.00	165274.00

Bank Details : State Bank of India, Vikroli West Branch - Branch no - 01406 , Account No - 33177702210, IFS Code - SBIN0001406	Subtotal :	165274.00
Amount in words : Rupees One Lakh Ninety Five Thousand Twenty Three Only	CGST 9% :	14874.66
	SGST 9% :	14874.66
	Grand Total	195023.32

Terms & conditions :

- 1) Payment term : Against Invoice
- 2) Warranty voids if payment commitment failed.
(Bounced cheque will also considered as failed commitment)
- 3) Interest @ 24% will be charged on overdue payment.
- 4) Goods once sold will not be taken back.
- 5) No TDS on Software Sales



Company's GST No : 27AAECT6857H1ZW
 Company's PAN No : AAECT6857H

Note:

Declaration : I/We hereby certify that my/our registration certificate under the Maharashtra Value Added Tax Act 2002 is in force on the date on which the sale of goods specified in this tax invoice is made by me/us and the transaction of sale covered by this tax invoice has been effected by me/us and it shall be accounted for in the turnover of sales while filling of return and the due to tax, if any payable on the sale has been paid or shall be paid.

for TechFlex Solutions Pvt Ltd



Authorised Sign



TechFlex Solutions Pvt Ltd
 F-412, Kailas Industrial Complex, Veer
 Sawarkar Marg, Near Hiranandani,
 Vikhroli W - 400079
 ContactNo:-022-41207788
 Email ID:-sheetalj@techflex.co.in
 State Code:-27

Tax Invoice

Bill To M/s. VIDYALANKAR DNYANAPEETH TRUST S Vidyalankar Institute of Technology (VIT) Vidyalankar College Marg, Wadala (E), Mumbai-400037 Contact No.24161126 GST No. State Code:27	Ship To M/s. VIDYALANKAR DNYANAPEETH TRUST S Vidyalankar Institute of Technology (VIT) Vidyalankar College Marg, Wadala (E), Mumbai-400037	Invoice No. TF-0443/Dec-2021 Invoice Date : 31/12/2021 Customer PO No.04641 PO Date :24/11/2021
Contact Person:Mr. Sunil Tubhe		

Sr. No.	Part No	Product Description	HSN	Unit Price	Qty	Tax(%)		Amount
						cgst	sgst	
1	IBM - HWMA	IBM - HWMA AMC, IBM X3650 Server AMC Serial No: 06BYNGH/06BYNGG/ 06BYNGK Support: 22/12/2021 To 21/12/2022	9987	86000.00	1	9.00	9.00	86000.00

Bank Details : State Bank of India, Vikhroli West Branch - Branch no - 01406 ,
 Account No - 33177702210, IFS Code - SBIN0001406

Subtotal :	86000.00
CGST 9% :	7740.00
SGST 9% :	7740.00
Grand Total	101480.00

Amount in words : Rupees One Lakh One Thousand Four Hundred Eighty Only

Terms & conditions :

- 1) Payment term : Against Invoice
- 2) Warranty voids if payment commitment failed.
(Bounced cheque will also considered as failed commitment)
- 3) Interest @ 24% will be charged on overdue payment.
- 4) Goods once sold will not be taken back.
- 5) No TDS on Software Sales

Company's GST No : 27AAECT6857H1ZW
 Company's PAN No : AAECT6857H

Note:

Declaration : I/We hereby certify that my/our registration certificate under the Maharashtra Value Added Tax Act 2002 is in force on the date on which the sale of goods specified in this tax invoice is made by me/us and the transaction of sale covered by this tax invoice has been effected by me/us and it shall be accounted for in the turnover of sales while filling of return and the due to tax, if any payable on the sale has been paid or shall be paid.



for TechFlex Solutions Pvt Ltd



Authorised Sign



TechFlex Solutions Pvt Ltd
F-412, Kailas Industrial Complex, Veer
Sawarkar Marg, Near Hiranandani,
Vikhroli W - 400079
ContactNo:-022-41207788
Email ID:-sheetalji@techflex.co.in
State Code:-27

Tax Invoice

Bill To	Ship To	Invoice No.
M/s. VIDYALANKAR DNYANAPEETH TRUST S Vidyalankar Institute of Technology (VIT) Vidyalankar College Marg, Wadala (E), Mumbai-400037 Contact No.24161126 GST No. State Code:27	M/s. VIDYALANKAR DNYANAPEETH TRUST S Vidyalankar Institute of Technology (VIT) Vidyalankar College Marg, Wadala (E), Mumbai-400037	TF-0414/Dec-2021 Invoice Date : 03/12/2021 Customer PO No.04639 PO Date :24/11/2021
Contact Person:Mr. Sunil Tubhe		

Sr. No.	Part No	Product Description	HSN	Unit Price	Qty	Tax(%)		Amount
						cgst	sgst	
1	XX433CTE S+XM433 CTAA+XS 433CTAA	SOPHOS XG 430 XSTREAM PROTECTION-36 MOS-RENEW AL+EMAIL PROTECTION+WEB SERVER PROTECTION, Support: 01/12/2021 To 30/11/2024	9973	435046.00	1	9.00	9.00	435046.00

Bank Details : State Bank of India, Vikroli West Branch - Branch no - 01406 ,
Account No - 33177702210, IFS Code - SBIN0001406

Amount in words : Rupees Five Lakh Thirteen Thousand Three Hundred Fifty
Four Only

Subtotal :	435046.00
CGST 9% :	39154.14
SGST 9% :	39154.14
Grand Total	513354.28

Terms & conditions :

- 1) Payment term : Against Invoice
- 2) Warranty voids if payment commitment failed.
(Bounced cheque will also considered as failed commitment)
- 3) Interest @ 24% will be charged on overdue payment.
- 4) Goods once sold will not be taken back.
- 5) No TDS on Software Sales

Company's GST No : 27AAECT6857H1ZW
Company's PAN No : AAECT6857H

Note:

Declaration : I/We hereby certify that my/our registration certificate under the Maharashtra Value Added Tax Act 2002 is in force on the date on which the sale of goods specified in this tax invoice is made by me/us and the transaction of sale covered by this tax invoice has been effected by me/us and it shall be accounted for in the turnover of sales while filling of return and the due to tax, if any payable on the sale has been paid or shall be paid.

for TechFlex Solutions Pvt Ltd



Authorised Sign



Invoice Number :
 Order Date:
 Purchase Order Number:

INI000094389
 02/12/2021
 4867/ST/NSG-SW/Shriram
 Value Services/21-22

Customer Address

Shriram Value Services (P) Ltd
 101-105, B Wing, Shiv Chambers,
 Sector 11, CBD Belapur,
 Above Indian Bank,
 Navi Mumbai Maharashtra 400614
 India

Reseller

TechFlex solutions Pvt Ltd

Please keep this License Schedule for future reference.

Some of our products and licenses require activation by you.
 If they do, there will be an "Action needed" section below with instructions.

Support

The following products and services are covered by Sophos support services.

Enhanced Support

XG 430 Xstream Protection - 36 MOS - RENEWAL

For details of how to access Sophos technical support, please see <https://www.sophos.com/support.aspx>.

Regional phone numbers for Sophos Support services:

Region	Country	Enhanced Support
UK	UK	0844 767 4670 (0844 SOPHOS-0) +44 (0) 1235 465818
APAC	Australia	1300 041 895 +61 2 9409 9111
	New Zealand	0800 884 012
	Singapore	+65 67 SOPHOS +60 3 6776 7467
	Malaysia	1800 816 542
	Philippines	+63 2 317 1699
	Hong Kong	+852 2527 3467
	China	+86 400 650 6598
	India	Toll Free: 1-800-419-6565 1-800-102-3535 Local: +91-79-66216565
DACH	Switzerland	+49 611 5858 1018 (German) +33 969 322 717 (French) +39 02 94 75 98 01 (Italian)



Vidyalankar Dnyanapeeth Trust's

Vidyalankar Institute of Technology
Vidyalankar College Marg, Wadala (E), Mumbai-400037
24161126
vidyalankar.edu.in

VIT Vidyalankar
Institute of
Technology

Purchase Order

To,

TECHFLEX SOLUTIONS PVT LTD

F406, KAILAS IND COMPLEX VEER SAWARKAR MARG, VIKHROLI(W), MUMBAI 79 - 400079

PO Number : 04641

PO Date : 24-11-2021

-/

Contact Person :—

Please arrange to supply following to Vidyalankar Institute of Technology.

Furnish Delivery Challan and Cash Memo / Invoice along with delivered goods.

Sr. No.	Item Name	Item Remarks	Quantity	Unit Rate (₹)	Total Amount (₹)	Add Taxes / GST
1	SERVICE CONTRACT	AMC - IBM X3650 SERVER (QTY 3) - S/N-06BYNGK S/N-06BYNGH S/N - 06BYNGG	1(Number)	86000.00	86000.00	18.00
Total Amount :					86000.00#	+ Taxes as Above
Round Off Amount :					₹ 86000.00	
Amount in Words :Eighty Six Thousand rupees only						

PO Remarks :PERIOD : 09.12.21 TO 08.12.22 (1 YEAR / 24X7 SUPPORT)

*AMOUNT WILL BE PAID AS PER PURCHASE ORDER OR AT ACTUALS, WHICHEVER IS LESS.

Principal

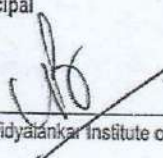
For Vidyalankar Institute of Technology (VIT)





TechFlex Solutions Pvt. Ltd.
F-406, Kailash Industrial Complex,
Veer Savarkar Marg,
Near Hiranandani (Powai),
Vikhroli (W) Mumbai - 400079
☎ +91-22-65880975

Part. No	Description	Unit Price	Qty	Total Amt
81Y9690	1TB Serial Attached SCSI (SAS) 2.5-inch 6G 7.2K NL SFF Hot-Swap Hard Drive	21100	04	84400
			VAT 5%	4220
			Total Value	88620

Terms and Conditions

1. Taxes : VAT 5% as mentioned above.
2. Octroi : If applicable.
3. Delivery : 1-2 weeks from the purchase order.
4. Payment : 100% Advance along with the PO.
5. Warranty : As per Principle warranty.





TechFlex

TechFlex Solutions Pvt Ltd
 F-412, Kailas Industrial Complex, Veer
 Sawarkar Marg, Near Hiranandani,
 Vikhroli W - 400079
 ContactNo:-022-41207788
 Email ID:-sheetalj@techflex.co.in
 State Code:-27

Tax Invoice

Bill To

M/s. VIDYALANKAR DNYANAPEETH TRUST S

Vidyalankar Institute of Technology (VIT)
 Vidyalankar College Marg, Wadala (E),
 Mumbai-400037
 Contact No.24161126
 GST No.
 State Code:27

Ship To

M/s. VIDYALANKAR DNYANAPEETH TRUST S
 Vidyalankar Institute of Technology (VIT)
 Vidyalankar College Marg, Wadala (E),
 Mumbai-400037

Invoice No.

TF-0312/Dec-2019

Invoice Date : 11/12/2019

Customer PO No.4074

PO Date :02/12/2019

Contact Person:Mr. Sunil Tubhe

Sr. No.	Part No	Product Description	HSN	Unit Price	Qty	Tax(%)		Amount
						cgst	sgst	
1	IBM - HWMA	IBM - HWMA AMC, AMC for IBM MX3650 Server 1Year Parts Labour On Site 24x7 4Hr response Serial No: 06BYNGK/06BYNGH/ 06BYNGG Support: 18/11/2019 To 17/11/2020	9987	30466.70	3	9.00	9.00	91400.10

Bank Details : State Bank of India, Vikroli West Branch - Branch no - 01406 ,
 Account No - 33177702210, IFS Code - SBIN0001406

Amount in words : Rupees One Lakh Seven Thousand Eight Hundred Fifty Two Only

Subtotal :	91400.10
CGST 9% :	8226.01
SGST 9% :	8226.01
Grand Total	107852.12

Terms & conditions :

- 1) Payment term : Against Invoice
- 2) Warranty voids if payment commitment failed.
(Bounced cheque will also considered as failed commitment)
- 3) Interest @ 24% will be charged on overdue payment.
- 4) Goods once sold will not be taken back.
- 5) No TDS on Software Sales



Company's GST No : 27AAECT6857H1ZW
 Company's PAN No : AAECT6857H

Note:

Declaration : I/We hereby certify that my/our registration certificate under the Maharashtra Value Added Tax Act 2002 is in force on the date on which the sale of goods specified in this tax invoice is made by me/us and the transaction of sale covered by this tax invoice has been effected by me/us and it shall be accounted for in the turnover of sales while filling of return and the due to tax, if any payable on the sale has been paid or shall be paid.

for TechFlex Solutions Pvt Ltd



Authorised Sign

Vidyalankar Dnyanapeeth Trust's

Vidyalankar Institute of Technology

Wadala (E), Vidyalankar College Marg, Mumbai-400037

+91 22 2416 11 26

vidyalankar.edu.in

VIT | Vidyalankar
Institute of
Technology
Accredited A+ by NAAC

GST No.: 27AAATV2195F1ZC

Purchase Order

To,

NETWORK TECHLAB (I) PVT LTD

41 SARVODAYA IND ESTATE ANDHERI(E) MUMBAI 93 - 400093

022-66814141 /

Contact Person :---

PO Number : 01185

PO Date : 04-09-2015

Please arrange to supply following to Vidyalankar Institute of Technology.

Furnish Delivery Challan and Cash Memo / Invoice along with delivered goods.

Sr. No.	Item Name	Item Remarks	Quantity	Unit Rate (₹)	Total Amount (₹)	Add Taxes (%)		
						VAT	ST	CST
1	SOPHOS(FIREWALL)	SG43TCHUS - SOPHOS SG 430 HARDWARE APPLIANCE - 25 GBPS FIREWALL THROUGHPUT, 8,000,000 CONCURRENT CONNECTION, 130,000 CONNECTION PER SECOND, 8 X GE FIXED PORT, 2 OPTIONAL FLEXI PORT OF 8 X GE COPPER, 8 X GE SFP, 2 X 10 GE SFP+	1(Number)	280000.00	280000.00	5.00	0.00	0.00
2	SOPHOS(FIREWALL)	FG433CSAA - SOPHOS SG 430 - FULLGUARD BUNDLE - 3 YEAR	1(Number)	60000.00	60000.00	5.00	14.00	0.00
3	SOPHOS(FIREWALL)	A5EZTCHUK - SOPHOS AP 55C ACCESS POINT, 3-YEAR WARRANTY - WITH POWER SUPPLY - WIFI 801.11N,DUAL- BAND/DUAL-RADIO, HIGH-DENSITY WLAN ENVIRONMENTS, 300 MBPS THROUGHPUT, 8 PER RADIO (16 IN TOTAL) SSID SUPPORT, 802.11 A/B/G/N 2.4 AND 5 GHZ, 2 EXTERNAL ANTENNAS, 2 RADIOS, 2 X 2:2 MIMO CAPABILITIES	40(Number)	14000.00	560000.00	5.00	0.00	0.00
Total Amount :					900000.00#	# + Taxes as Above		
Round Off Amount :					₹ 900000.00			
Amount in Words :Nine Lakhs rupees only								

PO Remarks :1) NO EXTRA CHARGES FOR INSTALLATION 2) LOCATION - SERVER ROOM

*AMOUNT WILL BE PAID AS PER PURCHASE ORDER OR AT ACTUALS, WHICHEVER IS LESS.

Principal

For Vidyalankar Institute of Technology (VIT)



TAX INVOICE - CUM - DELIVERY CHALLAN

Invoice No TF-080 / July -2014	Invoice Date 30-July-2014	Customer Po No 2256,2257,2258,2259	PO Date 30-June -2014
Bill to M/s. Vidyalankar Dayanooeth Trust's Vidyalankar Institute of Technology. Vidyalankar Educational Campus, Wadala E. Mumbai - 400 037. Contact Person : Mr. Milind Tadvalkar Contact No : 022-24161126	Ship to M/s. Vidyalankar Dnyanooeth Trust's Vidyalankar Institute of Technology. Vidyalankar Educational Campus, Wadala E, Mumbai - 400 037. Contact Person : Mr. Milind Tadvalkar Contact No : 022-24161126	Ship From M/s Agility Logistics Pvt Ltd. Bldg no A-7, Units No 1 - 16. Jumbo Bldg, Shree Ganesh Commercial Complex, Bhirwandi, Dist. Thane- 4213012	

Sr No	Part No	Product Description	Unit	Qty	Amount
1	7915NAR	x3650 M4, Xeon 8C E5-2640v2 95W 2.6GHz/1866MHz/20MB, 1x16GB, O/Bay HS 2.5in SAS/SATA, SR M5110e, 750W p/s, Rack	1200000	3	1200000.00
2	46W4365	Intel Xeon 8C Processor Model E5-2640v2 95W 2.6GHz/1866MHz/20MB		2	
3	46W0672	OPT RDIMM 16GB 2Rx4 4Gb LP 1.35V PC3- 12800 1600MHz		3	
4	90Y8877	IBM 300GB 2.5in SFF G2HS 10K 6Gbps SAS HDD		6	
5	94Y6669	IBM System x 550W High Efficiency Platinum AC Power Supply		3	
6	46M0902	IBM UltraSlim Enhanced SATA Multi-Burner		3	
7	39Y7927	Line cord - 2.8M 10A/250V C13(2P+Gnd) (India)		6	
Subtotal					1200000.00
Service Tax @ 12.36%					0.00
Vat 5%					60000.00
Total Amount					1260000.00

Amount in Rupees
Twelve Lakh Sixty Thousand Only.

Terms & conditions

- 1) Payment term : 50 % advance and 50 % against delivery.
- 2) Warranty voids if payment commitment failed.
(Bounced cheque will also considered as failed commitment)
- 3) Interest @ 24% will be charged on overdue payment.
- 4) Goods once sold will not be taken back.
- 5) No TDS on Software sales

VAT No: 27555265533V - w.e.f - 22.8.13
 CST No : 27555265533C - w.e.f - 22.8.13
 Company's S.T No AAECT6857HSD001
 Company's PAN No AAECT6857H

Bank Details
 TechFlex Solutions Pvt Ltd
 SBI - Vikroli West Branch - Branch no - 01406
 IFS Code - SBIN0001406
 Account No - 33177702210

Declaration

I/We hereby certify that my/our registration certificate under the Maharashtra Value Added Tax Act 2002 is in force on the date on which the sale of goods specified in this tax invoice is made by me/us and the transaction of sale covered by this tax invoice has been effected by me/us and it shall be accounted for in the turnover of sales while filling of return and the due to tax, if any payable on the sale has been paid or shall be paid.

for TECHFLEX SOLUTIONS PVT LTD



server installation done, good for payment

Milind
22/8/15

Purchase Order

To :
VELTECH
5 ANAND MANGAL JAMBHALI GALLI BORIVALI(W)
28997993 982052

23-Jul-2012
PO No. : 01901

Please arrange to supply following to VIDYALANKAR INSTITUTE OF TECHNOLOGY.
Furnish Delivery Challan and Cash Memo / Invoice along with delivered goods.

Sr.	Products	Description	Quantity	Unit Price ₹	Total Price ₹	Taxes (%)			
						Service Tax	Octroi	VAT	Other
1	SERVER	IBM x-3650M4 2U Rack Server - 7915 I5A	2 Numbers	160550.00	321100.00	0%	0%	0%	0%
Total Amount :					321100.00#	(# +Taxes as above)			
Round off Amount :					321100.00				

Note :All inclusive price.

Principal

For any queries, please contact on 24161126 Ext 9501.



VIDYALANKAR CAMPUS IT INFRASTRUCTURE

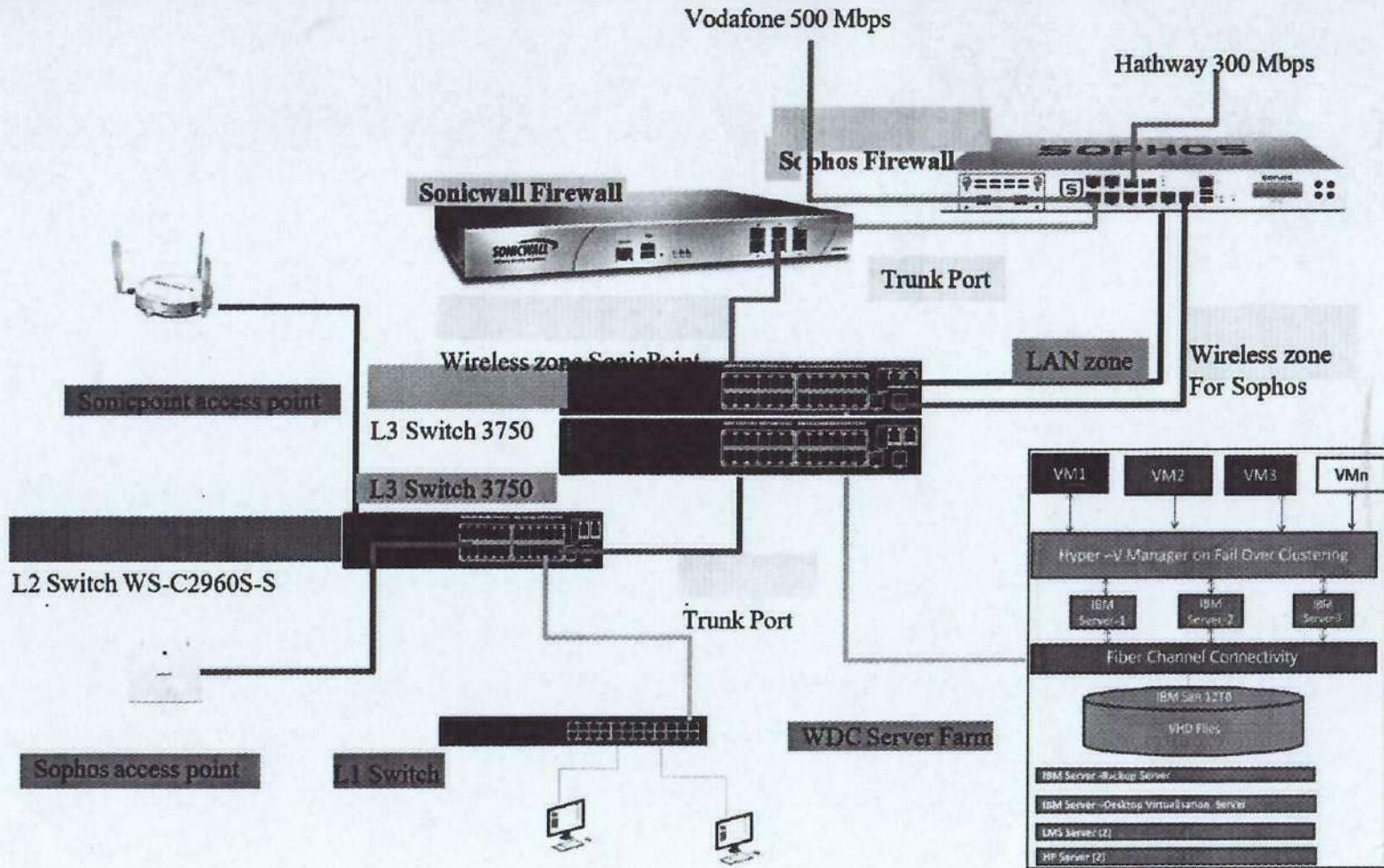

IT CAMPUS INFRASTRUCTURE

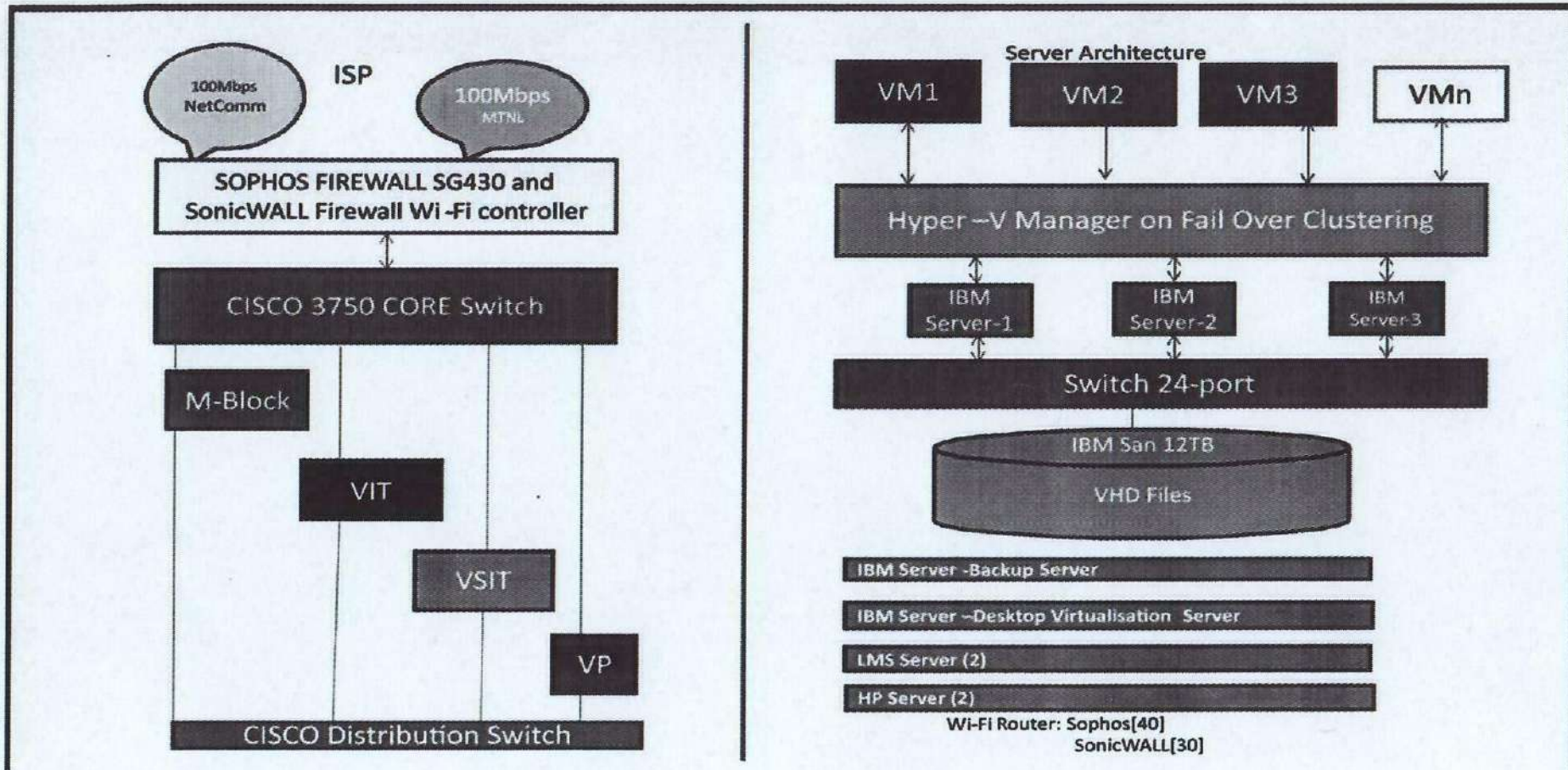

NETWORK DESIGN IN THE CAMPUS

- **A, B, C Class Network Used in campus for inter connectivity**
 - ✓ **A – Sonic Wall Wi-Fi**
 - ✓ **B – LAN Zone, SOPHOS Wi-Fi**
 - ✓ **C – Interconnectivity between L3 and L2 switches.**
- **Cisco L3 switches, Model - 3750x (24 x 10/100/1000 Ethernet port)**
- **Cisco L2 switches, Model - WS-C2960S-S (24 x 10/100/1000 Ethernet port)**
- **6 Core fiber optics Connectivity for Server room to M block, VP and VSIT Building.**
- **Dual Cable connectivity between L2 and L3 switches (Ether Channels)**
- **Use of Systemax passive components (Patch Cords, Patch Panels, etc.)**



SWITCHES

Cisco L3 Switch: 3750x (24 x 10/100/1000 Ethernet port)

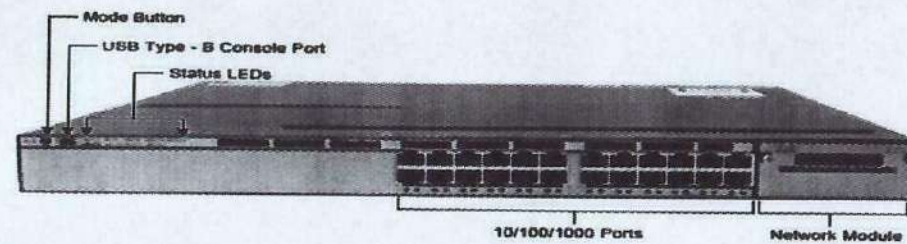

Features:

- Routing
- VLAN
- Stack and Load Balancing
- Fiber Port available
- DHCP

Location:

- Server room

Quantity:

- 2 nos. (Connected in Redundant)



SWITCHES

Cisco L2 Switch: WS-C2960S-S (24 x 10/100/1000 Ethernet port)

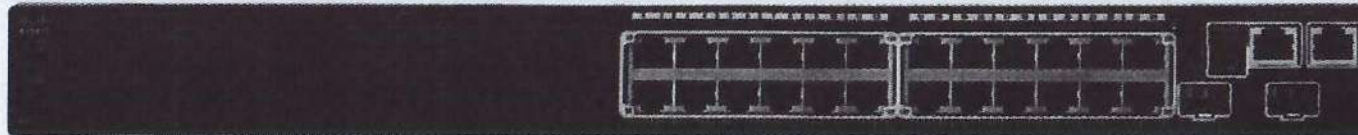

Features:

- VLAN
- Fiber Port available.
- MAC Address filtering

Location:

- Lab 3, Lab 15, one for VSIT, one for VP, and 4 for M Block.

Quantity :

- 8 nos



FIREWALL

Model: Sophos SG430

- Firmware Version: 17.5.7 MR-7
- CPUs: Intel Xeon Quad Core E3- 1225v5 @3.3 GHz
- Total Memory: 16 GB DDR4, 240 SSD

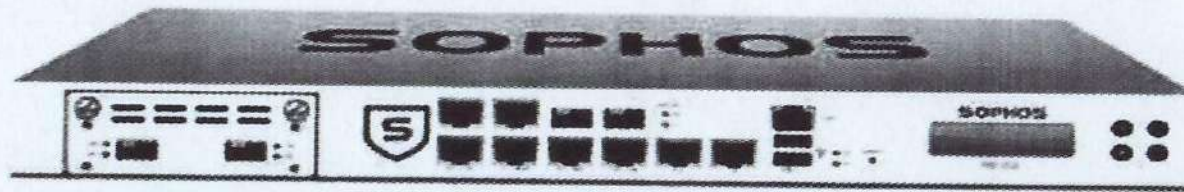

Zone 1	Zone 2	Zone 3	Zone 4	
LAN	SOPHOS Wireless Zone	Soniewall Wireless Zone	HATHWAY ISP (WLAN) (300 Mbps)	MTNL ISP(WLAN) (100Mbps)

Load balanced in the ratio of 60:40



FIREWALL

Feature:

- The Next-Gen advanced security platform.
- Wi-Fi Controller
- Web Filtering
- Application Filtering
- NAT
- Active Directory Authentication



FIREWALL

Access Control List

Local service ACL

Zone	Admin services			Authentication services					Network services		Other services						
	HTTPS	Telnet	SSH	NTLM	Captive portal	Radius SSO	Client Authentication	Chromebook SSO	Ping/Ping6	DNS	Wireless Protection	SSL VPN	Web proxy	User Portal	Dynamic Routing	SMTP Relay	SNMP
LAN	<input checked="" type="checkbox"/>	<input type="checkbox"/>	<input checked="" type="checkbox"/>	<input type="checkbox"/>	<input checked="" type="checkbox"/>	<input checked="" type="checkbox"/>	<input checked="" type="checkbox"/>	<input checked="" type="checkbox"/>	<input checked="" type="checkbox"/>	<input checked="" type="checkbox"/>	<input checked="" type="checkbox"/>	<input checked="" type="checkbox"/>	<input checked="" type="checkbox"/>	<input checked="" type="checkbox"/>	<input type="checkbox"/>	<input checked="" type="checkbox"/>	<input checked="" type="checkbox"/>
WAN	<input checked="" type="checkbox"/>	<input type="checkbox"/>	<input checked="" type="checkbox"/>	<input type="checkbox"/>	<input type="checkbox"/>	<input type="checkbox"/>	<input type="checkbox"/>	<input type="checkbox"/>	<input checked="" type="checkbox"/>	<input type="checkbox"/>	<input type="checkbox"/>	<input checked="" type="checkbox"/>	<input type="checkbox"/>	<input checked="" type="checkbox"/>	<input type="checkbox"/>	<input type="checkbox"/>	<input type="checkbox"/>
DMZ	<input type="checkbox"/>	<input type="checkbox"/>	<input type="checkbox"/>	<input type="checkbox"/>	<input type="checkbox"/>	<input type="checkbox"/>	<input type="checkbox"/>	<input type="checkbox"/>	<input type="checkbox"/>	<input type="checkbox"/>	<input type="checkbox"/>	<input checked="" type="checkbox"/>	<input type="checkbox"/>	<input checked="" type="checkbox"/>	<input type="checkbox"/>	<input type="checkbox"/>	<input checked="" type="checkbox"/>
VPN	<input checked="" type="checkbox"/>	<input type="checkbox"/>	<input type="checkbox"/>	<input type="checkbox"/>	<input type="checkbox"/>	<input type="checkbox"/>	<input checked="" type="checkbox"/>	<input type="checkbox"/>	<input checked="" type="checkbox"/>	<input type="checkbox"/>	<input type="checkbox"/>	<input type="checkbox"/>	<input type="checkbox"/>	<input type="checkbox"/>	<input type="checkbox"/>	<input type="checkbox"/>	<input checked="" type="checkbox"/>
WiFi	<input checked="" type="checkbox"/>	<input type="checkbox"/>	<input checked="" type="checkbox"/>	<input type="checkbox"/>	<input checked="" type="checkbox"/>	<input checked="" type="checkbox"/>	<input checked="" type="checkbox"/>	<input checked="" type="checkbox"/>	<input checked="" type="checkbox"/>	<input checked="" type="checkbox"/>	<input checked="" type="checkbox"/>	<input checked="" type="checkbox"/>	<input checked="" type="checkbox"/>	<input checked="" type="checkbox"/>	<input type="checkbox"/>	<input checked="" type="checkbox"/>	<input checked="" type="checkbox"/>
Sonicwall	<input type="checkbox"/>	<input type="checkbox"/>	<input type="checkbox"/>	<input type="checkbox"/>	<input checked="" type="checkbox"/>	<input type="checkbox"/>	<input type="checkbox"/>	<input type="checkbox"/>	<input type="checkbox"/>	<input type="checkbox"/>	<input checked="" type="checkbox"/>	<input type="checkbox"/>	<input type="checkbox"/>	<input type="checkbox"/>	<input type="checkbox"/>	<input checked="" type="checkbox"/>	<input checked="" type="checkbox"/>



WIRELESS NETWORK

Enterprise-level Wireless Access Points (Sophos AP 55, AP55C)

- 38 Access Points located at various locations
- Centralized Management
- Easily switch between access points without any disconnection
- Login based authentication

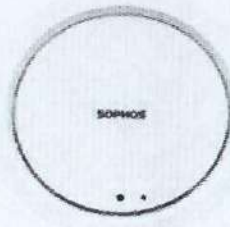
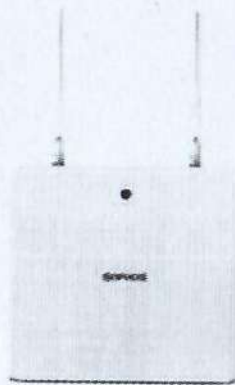

SOPHOS SG430



Categories of Websites allowed

- Web Communications
- Job Search
- News & Media
- References
- Sports/Recreation
- Business & Economy
- Education
- Cultural Institutions
- Government
- Information Technology / Computers
- Search Engines & Portals



WDC SERVER FARM

IBM Server System X 3650-M4 (2 nos)

- **Xeon 4 core Processor 2.4 GHz**
- **48 GB of RAM Speed 1333 MHz**

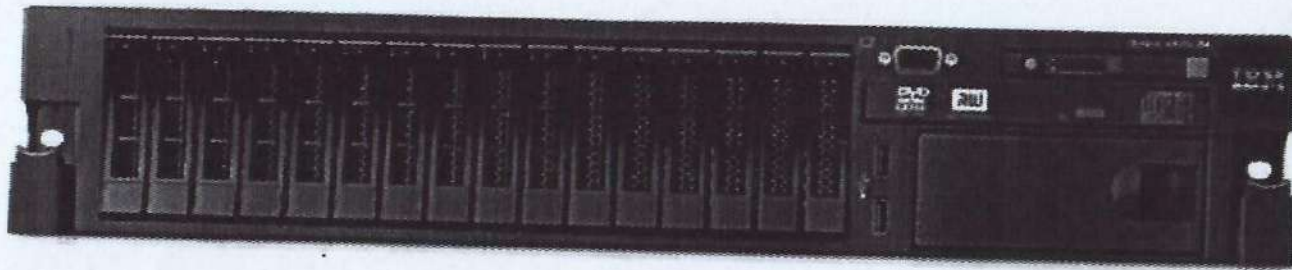

VSIT LAB X-103

VLAN-204

D-Link 24 Port Switch

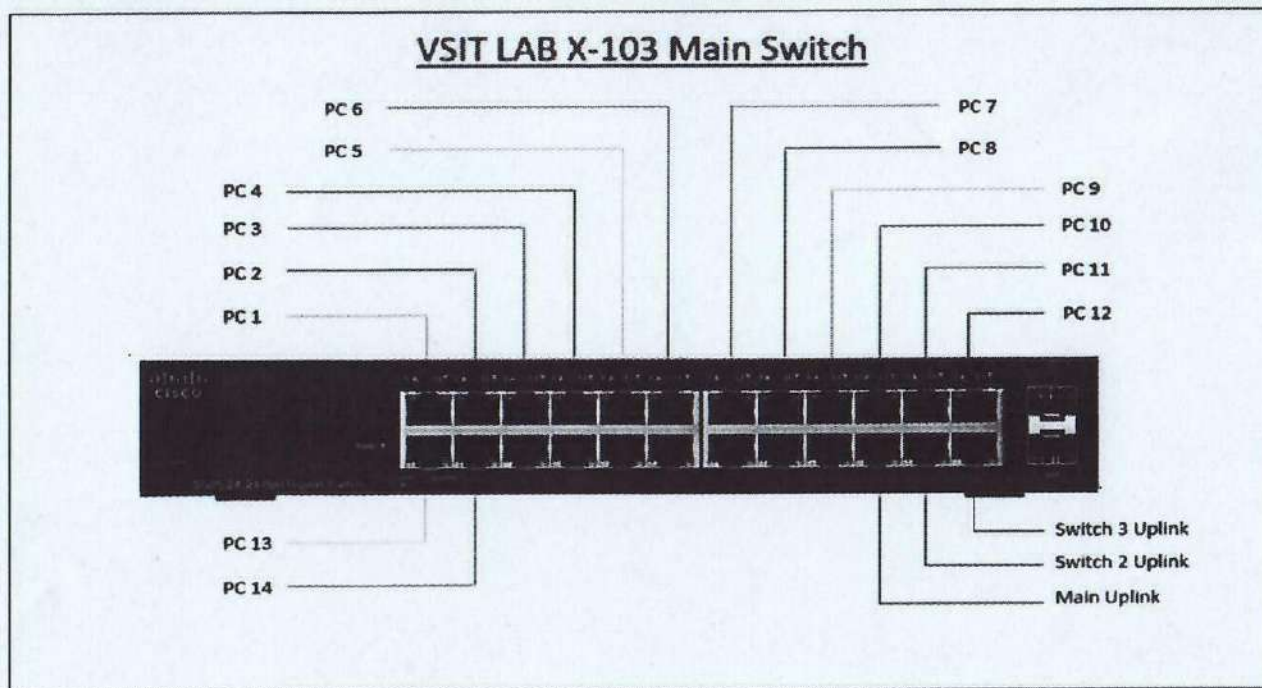

VSIT LAB X-103

VLAN-204

D-Link 24 Port Switch

